

OKUMA (VDI30)

LT10M - LT200M

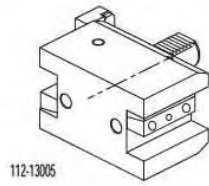

112-13005

Face and I.D.
cutting holder

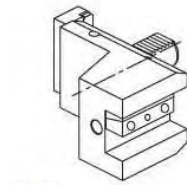

112-33008

Face and I.D.
cutting holder

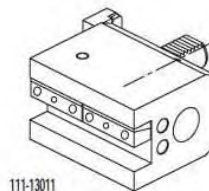

111-13011

Face and O.D.
cutting holder

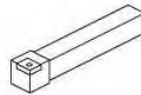

Qualified tool
20x20 mm

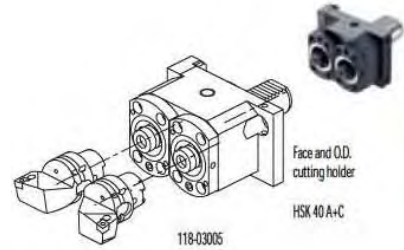

118-03005

Face and O.D.
cutting holder

HSK 40 A+C

Cut-off holder

26 mm

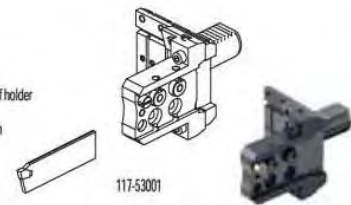

117-53001

Boring bar holder

HSK 40 A+C

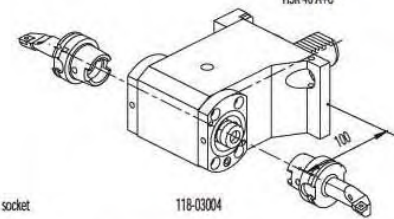

118-03004

ACCESSORIES

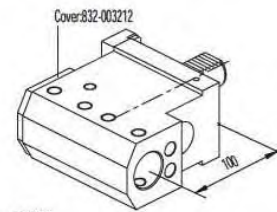

115-23045

Cover:832-003212

Combi toolholder
for boring bar and
insertdrill with internal
coolant

Ø32 mm

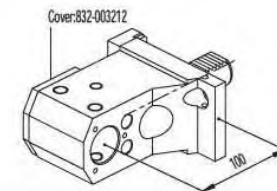

115-23046

Cover:832-003212

Combi toolholder
for boring bar and
insertdrill with internal
coolant

Ø32 mm

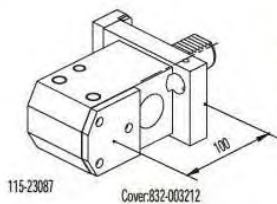
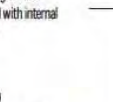

115-23087

Cover:832-003212

Combi toolholder
for boring bar and
insertdrill with internal
coolant

Ø32 mm

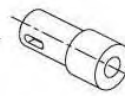

Drill socket

115-63282 <MT1>

115-63284 <MT2>

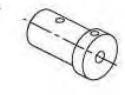

Boring bar sleeve

115-63286 (Ø8 mm)

115-63288 (Ø10 mm)

115-63290 (Ø12 mm)

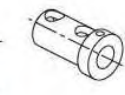

Boring bar sleeve

115-63292 (Ø16 mm)

115-63294 (Ø20 mm)

115-63296 (Ø25 mm)



OKUMA (VDI40)

LT15M - LT300M - MT250 - LB300

112-14009 Face and O.D. cutting holder

111-14014 Face and O.D. cutting holder

Qualified tool 25x25 mm

118-04012 Face and O.D. cutting holder HSK 40 A+C

117-54005 Cut-off holder 32 mm

ACCESSORIES

Cover:832-003104 Combi toolholder for boring bar and insertdrill with internal coolant. 105 mm 840 mm 115-24081

Cover:832-003104 Combi toolholder for boring bar and insertdrill with internal coolant. 105 mm 840 mm 115-24070

Cover:832-003104 Combi toolholder for boring bar and insertdrill with internal coolant. 105 mm 840 mm 115-54060

Drill socket
115-64094 <MT1>
115-64095 <MT2>
115-64096 <MT3>

Boring bar sleeve and throw-away drill socket
115-64097 (Ø10 mm)
115-64098 (Ø12 mm)
115-64099 (Ø16 mm)
165-64001 (Ø20 mm)

Boring bar sleeve and throw-away drill socket
165-64002 (Ø25 mm)
165-64003 (Ø32 mm)

Boring bar holder HSK 40 A+C 105 mm 118-04011

Boring bar sleeve
165-64004 (Ø10 mm)
165-64005 (Ø12 mm)
165-64006 (Ø16 mm)
165-64007 (Ø20 mm)

Boring bar sleeve
165-64008 (Ø25 mm)
165-64009 (Ø32 mm)

OKUMA

LB15II - LB300 / HAAS SL20 - SL30

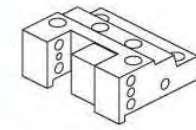

128-42011

Face and O.D. cutting holder

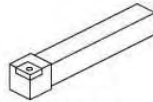

Qualified tool
25x25 mm

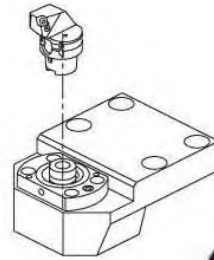

128-12039

Face and O.D. cutting holder

HSK 40 A+C

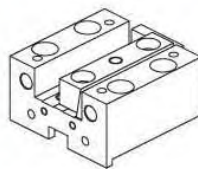

128-32001

Face and I.D. cutting holder



CONNECTION

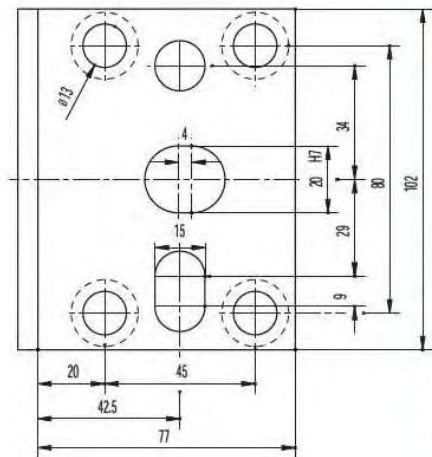

ACCESSORIES

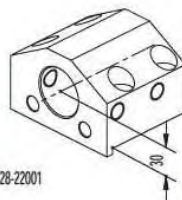

128-22001

Toolholder for boring bar



Ø40 mm

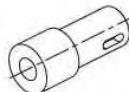

Drill socket

165-64010 <MT1>
165-64011 <MT2>
165-64012 <MT3>

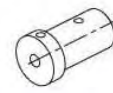

Boring bar sleeve and throw-away drill socket

165-64135 (Ø8 mm)
165-64013 (Ø10 mm)
165-64014 (Ø12 mm)
165-64015 (Ø16 mm)
165-64016 (Ø20 mm)



Boring bar sleeve and throw-away drill socket

165-64017 (Ø25 mm)
165-64018 (Ø32 mm)

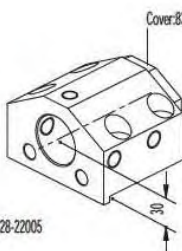

128-22005

Cover: 832-003056

Combi toolholder for boring bar and insert drill with internal coolant

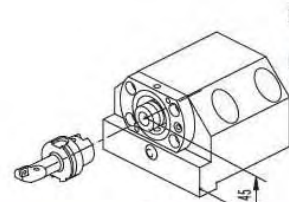
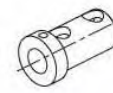

128-12040

Boring bar holder

HSK 40 A+C

OKUMA (VDI40)

LB15IIMW

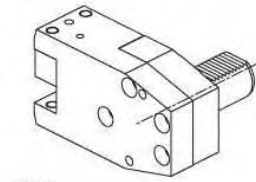

112-24007

Face and I.D.
cutting holder

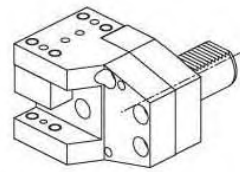

111-64005

Face and O.D.
cutting holder

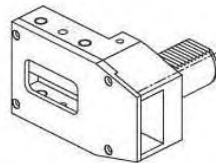

111-64006

Face and O.D.
cutting holder

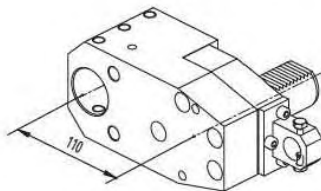

115-24068

Toolholder
for boring bar

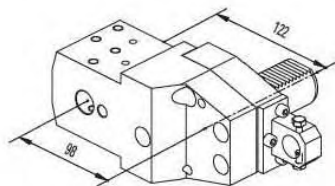

115-24067

Double toolholder
for boring bar

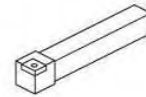

Qualified tool
25x25 mm

ACCESSORIES

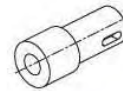

Drill socket

- 165-64021 <MT1>
- 165-64022 <MT2>
- 165-64023 <MT3>

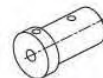

Boring bar sleeve

- 165-64024 (Ø10 mm)
- 165-64025 (Ø12 mm)
- 165-64026 (Ø16 mm)
- 165-64027 (Ø20 mm)



Boring bar sleeve

- 165-64028 (Ø25 mm)
- 165-64029 (Ø32 mm)



OKUMA (VDI40)

LB300IIMW

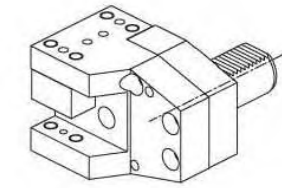

111-64009

Face and O.D.
cutting holder

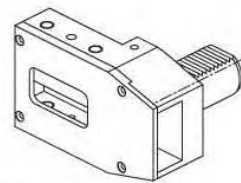

111-64006

Face and O.D.
cutting holder

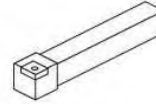

Qualified tool
25x25 mm

ACCESSORIES

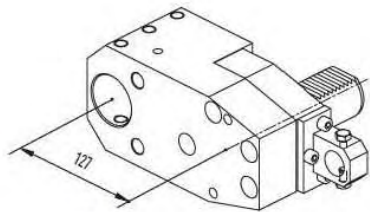

115-24093

Toolholder
for boring bar

Ø40 mm

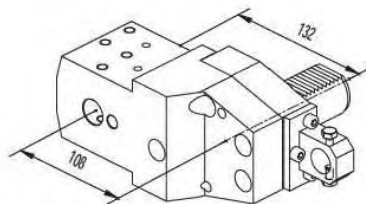

115-24092

Double toolholder
for boring bar

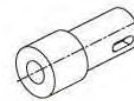

Drill socket

- 165-64021 <MT1>
- 165-64022 <MT2>
- 165-64023 <MT3>



Boring bar sleeve

- 165-64024 (Ø10 mm)
- 165-64025 (Ø12 mm)
- 165-64026 (Ø16 mm)
- 165-64027 (Ø 20 mm)

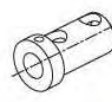
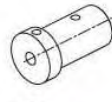

Boring bar sleeve

- 165-64028 (Ø25 mm)
- 165-64029 (Ø32 mm)



OKUMA

Mac Turn 250/350/400 Multus B250/B300/B400

ATC Turret (HSK63A) ICTM STANDARD

For turning

45°
90°

141-11405 25x25 mm 141-11409 25x25 mm 142-11402 25x25 mm 142-21401 (left) 25x25 mm 142-11403 (right) 25x25 mm 141-11406 25x25 mm

141-11407 (left) 25x25 mm 141-21401 (right) 25x25 mm H63ADCM12DDM15-L145 142-11405 32x32/25x25 mm 142-21404 20x20 mm (right) 142-21403 20x20 mm (left) CUT-OFF HOLDER
147-51405 (26mm,left) 147-51406 (26mm,right) 147-51407 (32mm,left) 147-51408 (32mm,right)

H63APCMNR12-L145 H63APDNMR15-L145 BORING BAR HOLDER
145-21404 (Ø12) 145-21406 (Ø16) 145-21408 (Ø20) 145-21409 (Ø25) 145-21410 (Ø32) 145-21411 (Ø40) 145-21412 Ø40 mm

H63ADDMNL15-L145 H63ADVMNL16-L145 165-64124 (Ø10 mm) 165-64125 (Ø12 mm) 165-64126 (Ø16 mm) 165-64127 (Ø20 mm) 165-64128 (Ø25 mm) 165-64129 (Ø32 mm)

H63ASDNCN11-L145 H63ASVVCN16-L145 145-11406 (Ø16) 145-11408 (Ø20) 145-11409 (Ø25) 145-11410 (Ø32) 145-11411 (Ø40)

OKUMA

Mac Turn 250/350/400

Lower Turret (VDI 40)

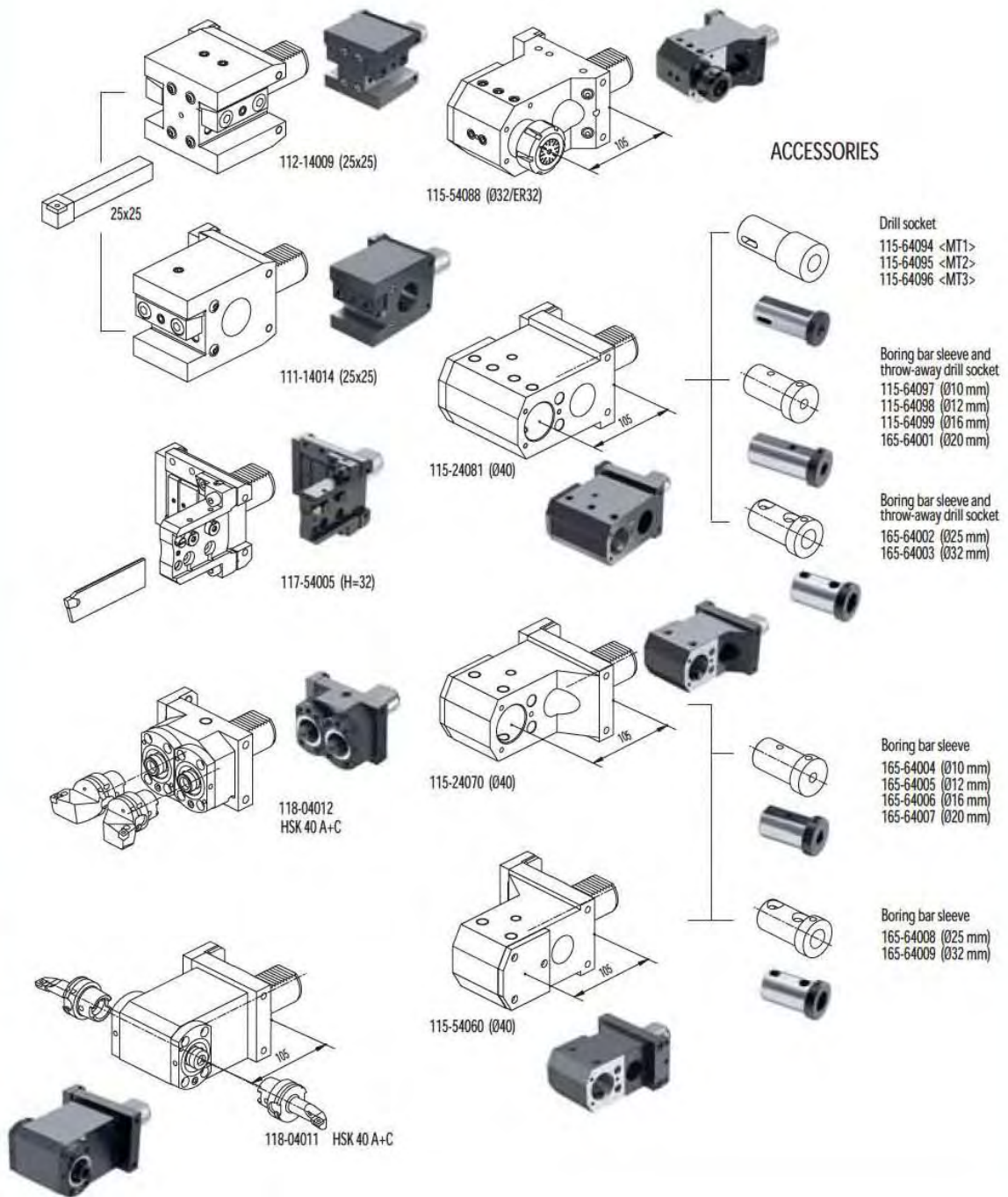

OKUMA

Mac Turn 550

ATC Turret (HSK100A) ICTM STANDARD

For turning

45°

141-11603 25x25 mm

141-11601 25x25 mm

90°

142-11607 25x25 mm

142-11608 25x25 mm

H100APCMNR12-L160

142-21605 25x25 mm

141-11602 25x25 mm

H100APDNNR15-L160

BORING BAR HOLDER

H100ASVVCN16-L160

145-21608 Ø50 mm

H100ADCM12DDM15-L160

115-65089 (Ø16 mm)

115-65090 (Ø20 mm)

115-65091 (Ø25 mm)

115-65092 (Ø32 mm)

115-65093 (Ø40 mm)

OKUMA

Mac Turn 550

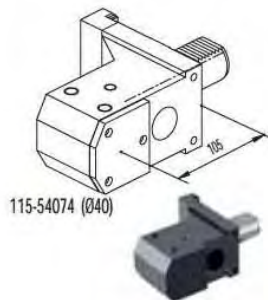
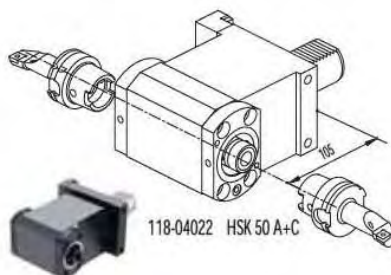
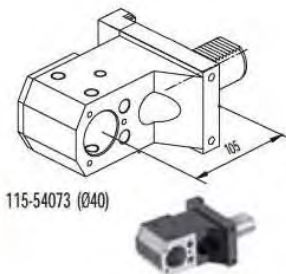
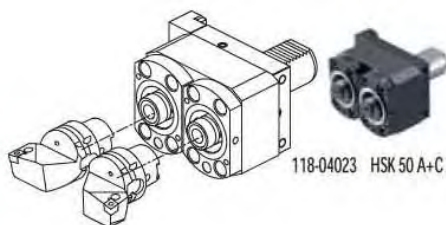
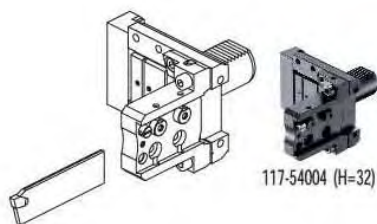
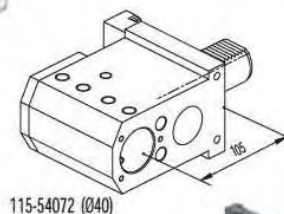
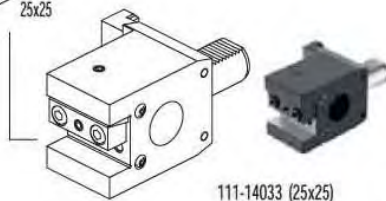
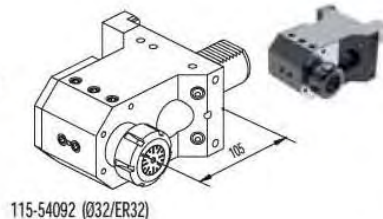
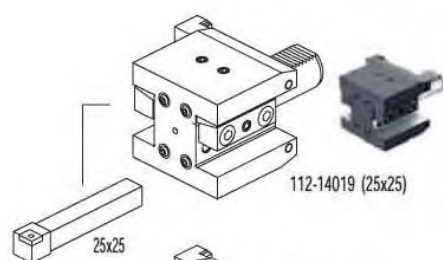

ACCESSORIES

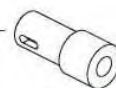

Drill socket
 115-64094 <MT1>
 115-64095 <MT2>
 115-64096 <MT3>



Boring bar sleeve and
 throw-away drill socket
 115-64097 (Ø10 mm)
 115-64098 (Ø12 mm)
 115-64099 (Ø16 mm)
 165-64001 (Ø20 mm)



Boring bar sleeve and
 throw-away drill socket
 165-64002 (Ø25 mm)
 165-64003 (Ø32 mm)



Boring bar sleeve
 165-64124 (Ø10 mm)
 165-64125 (Ø12 mm)
 165-64126 (Ø16 mm)
 165-64127 (Ø20 mm)

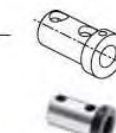
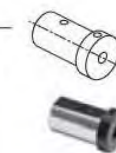

Boring bar sleeve
 165-64008 (Ø25 mm)
 165-64009 (Ø32 mm)

OKUMA (VDI40)

LVT300

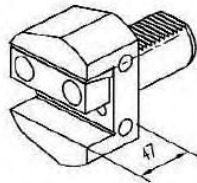

111-14041

Face and O.D. cutting holder

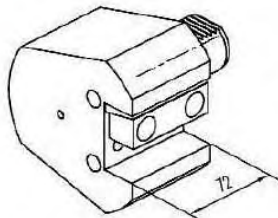

112-14021

Face and O.D. cutting holder

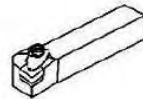

Qualified tool
25x25 mm

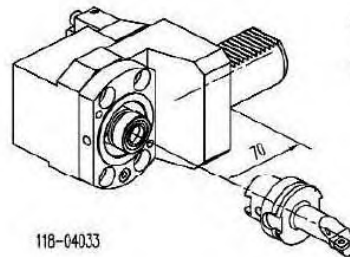

118-04033

Boring bar holder
HSK 50 A+C

ACCESSORIES

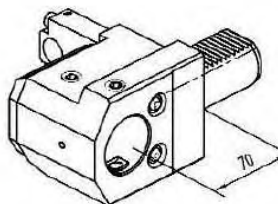

115-54068

Combi toolholder
for boring bar and
insertdrill
ø40 mm

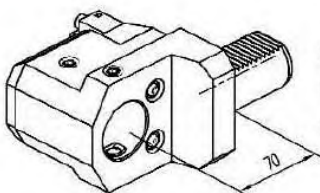

Combi toolholder
for boring bar and
insertdrill
ø40 mm

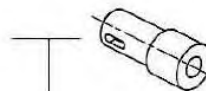

Drill socket

- 114-34034 <MT1>
- 114-34035 <MT2>

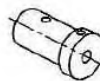

Boring bar sleeve

- 165-64124 (ø10 mm)
- 165-64125 (ø12 mm)
- 165-64126 (ø16 mm)
- 165-64127 (ø20 mm)

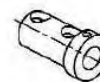

Boring bar sleeve

- 165-64128 (ø25 mm)
- 165-64129 (ø32 mm)

OKUMA

LB2000 EX (M, MY)

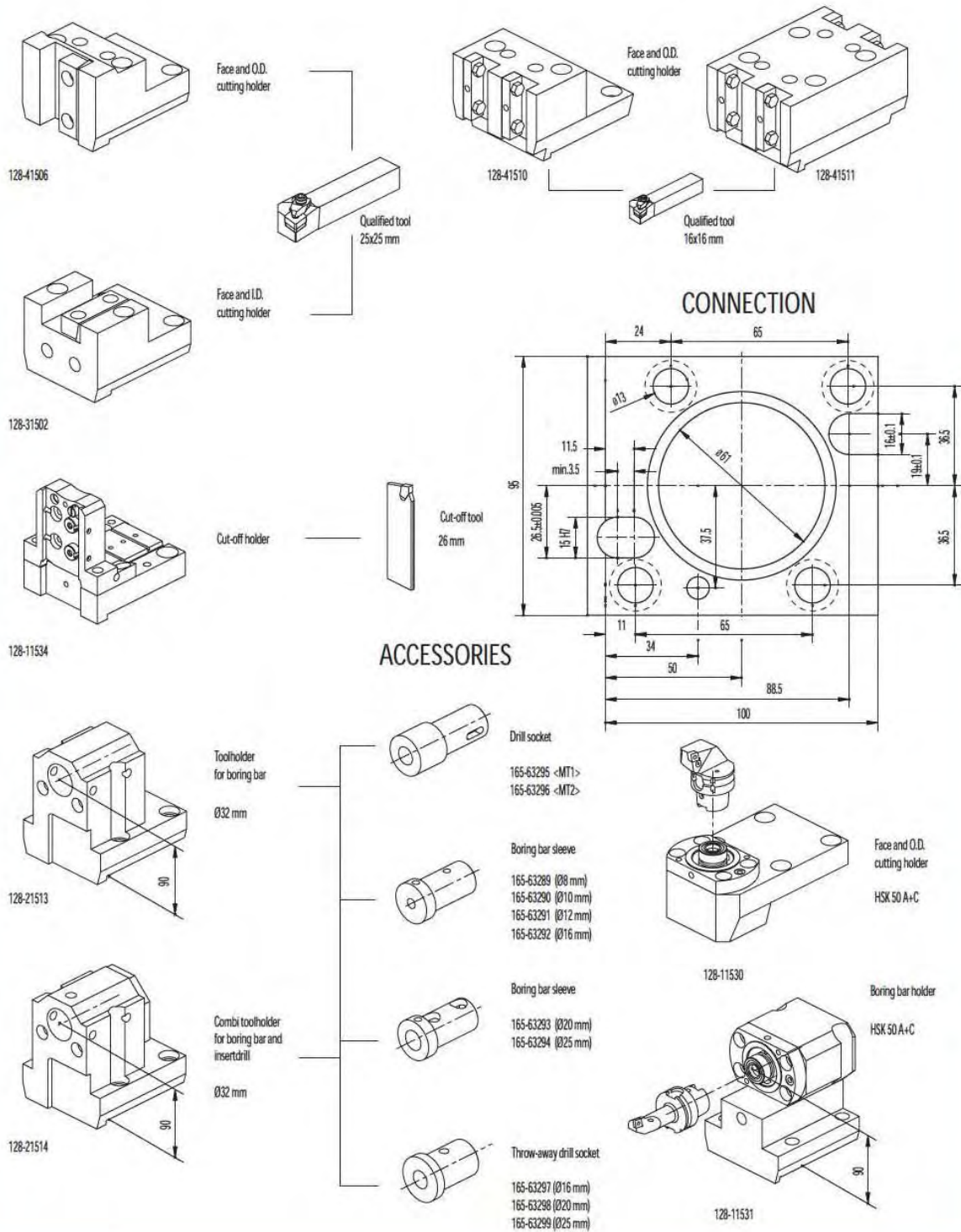

OKUMA

LB2500 EX (M) LB3000 EX (M, MY)

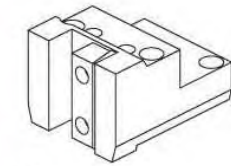

128-41507

Face and O.D.
cutting holder

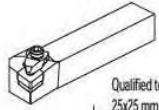

Qualified tool
25x25 mm

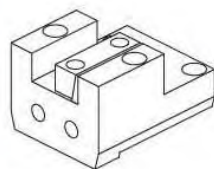

128-31503

Face and I.D.
cutting holder

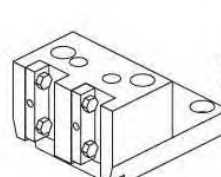

128-41510

Face and O.D.
cutting holder

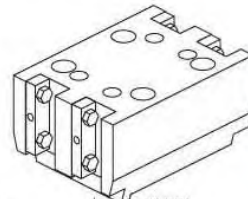

128-41511

Qualified tool
16x16 mm

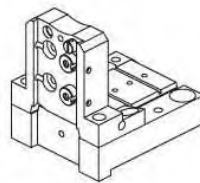

128-11535 (h=32 mm)
128-11534 (h=26 mm)

Cut-off holder



Cut-off tool
32 mm
26 mm

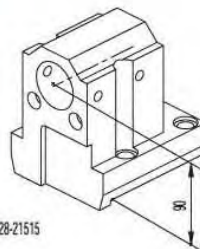

128-21515

Toolholder
for boring bar

Ø40 mm

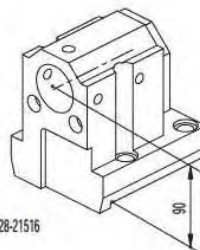

128-21516

Combi toolholder
for boring bar and
insert drill

Ø40 mm

ACCESSORIES

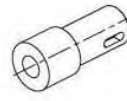

Drill socket

165-64010 <MT1>
165-64011 <MT2>
165-64012 <MT3>



Boring bar sleeve

165-64135 (Ø8 mm)
165-64013 (Ø10 mm)
165-64014 (Ø12 mm)
165-64015 (Ø16 mm)
165-64016 (Ø20 mm)

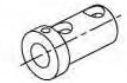

Boring bar sleeve

165-64019 (Ø25 mm)
165-64020 (Ø32 mm)



Throw-away drill socket

165-64203 (Ø16 mm)
165-64204 (Ø20 mm)
165-64205 (Ø25 mm)
165-64206 (Ø32 mm)

CONNECTION

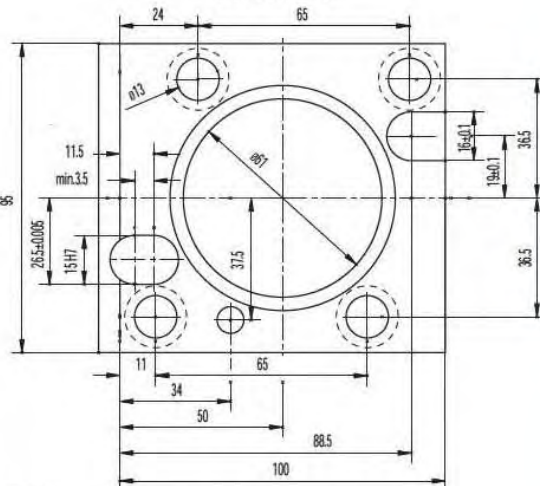

128-11530

Face and O.D.
cutting holder

HSK 50 A+C

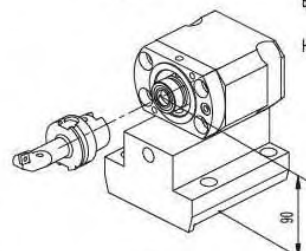

128-11531

Boring bar holder

HSK 50 A+C

OKUMA

LB3000 EX (MW, MYW)

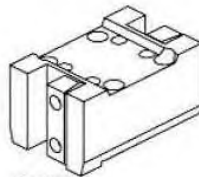

128-41509

Face and O.D. cutting holder

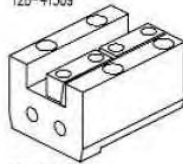

128-31505

Face and I.D. cutting holder

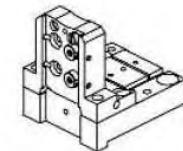

128-11535 (h=37 mm)
128-11534 (h=26 mm)

Cut-off holder

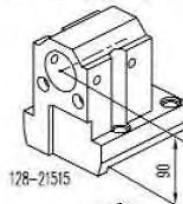

128-21515

Toolholder for boring bar

Ø40 mm

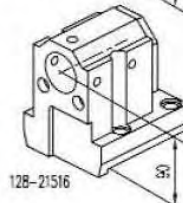

128-21516

Combi toolholder for boring bar and insertdrill

Ø40 mm

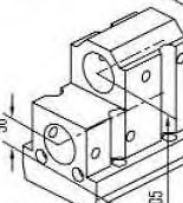

128-21519

Double toolholder for boring bar

Ø40 mm

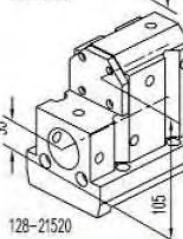

128-21520

Double combi toolholder for boring bar and insertdrill

Ø40 mm

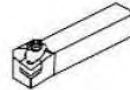

Qualified tool
25x25 mm

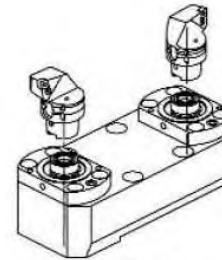

128-11537

Face and O.D. cutting holder
HSK 50 A+C

CONNECTION

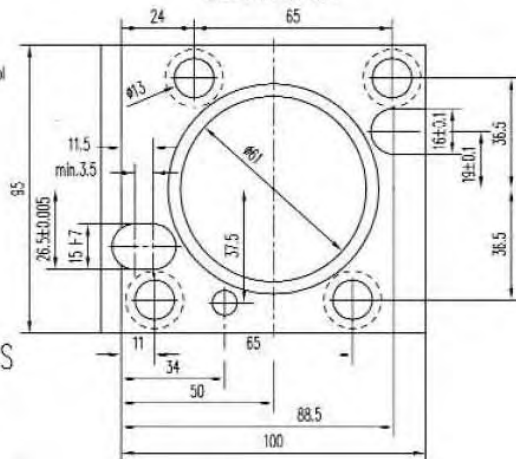

ACCESSORIES



Cut-off tool
32 mm
26 mm

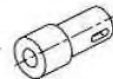

Drill socket

- 165-64010 <M11>
- 165-64011 <M12>
- 165-64012 <M13>

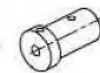

Boring bar sleeve

- 165-64135 (Ø8 mm)
- 165-64013 (Ø10 mm)
- 165-64014 (Ø12 mm)
- 165-64015 (Ø16 mm)
- 165-64016 (Ø20 mm)



Boring bar sleeve

- 165-64019 (Ø25 mm)
- 165-64020 (Ø32 mm)



Throw-away drill socket

- 165-64203 (Ø16 mm)
- 165-64204 (Ø20 mm)
- 165-64205 (Ø25 mm)
- 165-64206 (Ø32 mm)

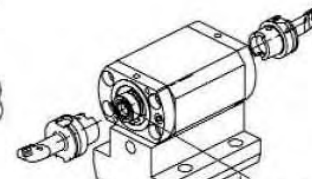

128-11538

Boring bar holder
HSK 50 A+C

OKUMA

LB4000 EX (M, MY)

