

# GILDEMEISTER (VDI30)

**CTX 210/310/410 V3/V1 - CTX 320/420 V3**  
**CTX Alpha 300/500 V3**  
**CTX Beta 500/800/1250 V3 (option)**  
**CTV 160**

## AXIAL TORRET

**Face and O.D. cutting holder**

B1-30x20x40

**Face and O.D. cutting holder overhead**

B3-30x20x40

**Face and O.D. cutting holder**

B5-30x20x40

**Face and O.D. cutting holder overhead**

B7-30x20x40

**Cut-off holder**

26 mm

AR3026

**Bar puller**

KH1-30

**VDI damped, adjustable, stop bar**

MW-3042-AM

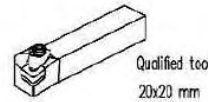
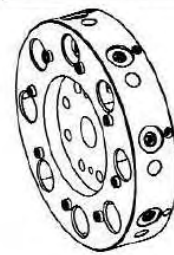

Qualified tool  
20x20 mm

## ACCESSORIES

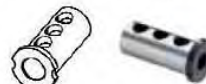

E2-115

Boring bar sleeve #25 mm

- 115-62574 (Ø8 mm)
- 115-62575 (Ø10 mm)
- 115-62576 (Ø12 mm)
- 115-62577 (Ø16 mm)
- 115-62578 (Ø20 mm)

Boring bar sleeve #32 mm

- 165-63223 (Ø8 mm)
- 165-63224 (Ø10 mm)
- 165-63225 (Ø12 mm)
- 165-63226 (Ø16 mm)
- 165-63227 (Ø20 mm)
- 165-63228 (Ø25 mm)

Boring bar sleeve #40 mm

- 165-64075 (Ø8 mm)
- 165-64076 (Ø10 mm)
- 165-64077 (Ø12 mm)
- 165-64078 (Ø16 mm)
- 165-64079 (Ø20 mm)
- 165-64080 (Ø25 mm)
- 165-64081 (Ø32 mm)

Toolholder for insert drill

- E1-30x06MN (Ø6 mm)
- E1-30x08MN (Ø8 mm)
- E1-30x10MN (Ø10 mm)
- E1-30x12MN (Ø12 mm)
- E1-30x16 (Ø16 mm)
- E1-30x20 (Ø20 mm)
- E1-30x25 (Ø25 mm)
- E1-30x32 (Ø32 mm)
- E1-30x40 (Ø40 mm)



Toolholder for boring bar

- E2-30x6 (Ø6 mm)
- E2-30x8 (Ø8 mm)
- E2-30x10 (Ø10 mm)
- E2-30x12 (Ø12 mm)
- E2-30x16 (Ø16 mm)
- E2-30x20 (Ø20 mm)
- E2-30x25 (Ø25 mm)
- E2-30x32 (Ø32 mm)
- E2-30x40 (Ø40 mm)



Double holder for boring bar

E7-30x25 (Ø25 mm)

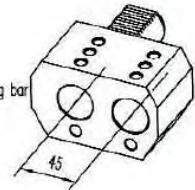

Toolholder with cylindrical shank

137-00041 (Ø40 mm/HSK50A+C)



Collet chuck

- E4-30x16 (ER16)
- E4-30x20 (ER20)
- E4-30x25 (ER25)
- E4-30x32 (ER32)
- E4-30x40 (ER40)



Drilling chuck

- KS2-30-13 (Ø1-Ø13 mm)
- KS2-30-16 (Ø3-Ø16 mm)



# GILDEMEISTER (VDI30)

CTX 310/410 V4/V6 - CTX 320 V4/V6  
 CTX 420 V4/V6 (option) - CTX Alpha 300 V4  
 CTX Alpha 500 V 4/V6  
 CTX Beta 500/800/1250 V4/V6 (option)  
 TWIN 42/65/102  
 SPRINT 65

## RADIAL TORRET

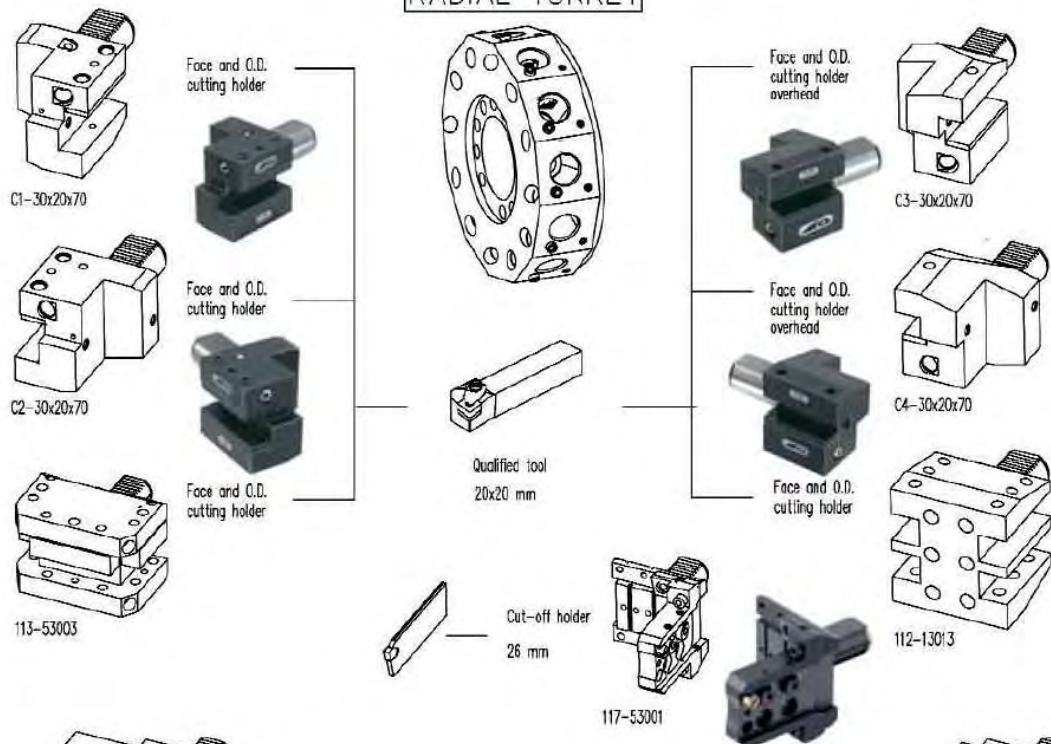

## VDI30/VDI30 ADAPTORS

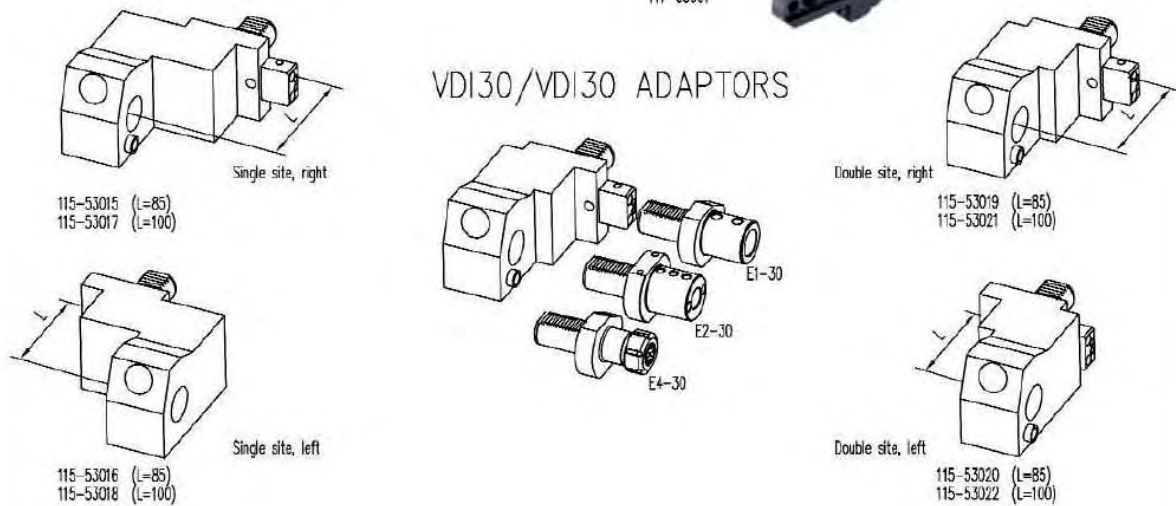

# GILDEMEISTER (VDI30)

CTX310/410 V4/V6 - CTX 320 V4/V6  
 CTX420 V4/V6 (option) - CTX Alpha 300 V4  
 CTX Alpha 500 V4/V6  
 CTX Beta 500/800/1250 V4/V6 (option)  
 TWIN 42/65/102  
 SPRINT 65

## RADIAL TORRET

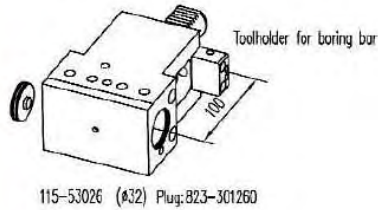
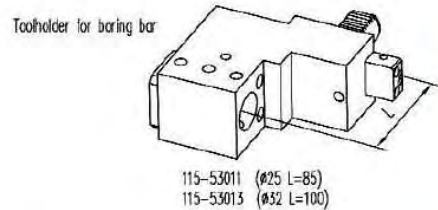
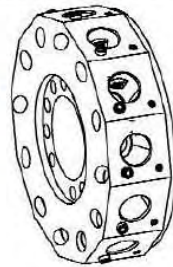
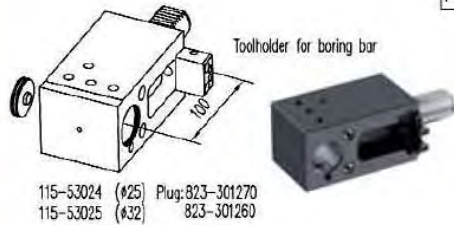

## ACCESSORIES

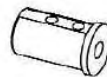

Boring bar sleeve Ø25 mm

- 165-82519 (Ø6 mm)
- 165-82520 (Ø8 mm)
- 165-82521 (Ø10 mm)
- 165-82522 (Ø12 mm)

Boring bar sleeve Ø32 mm

- 165-83301 (Ø6 mm)
- 165-83302 (Ø8 mm)
- 165-83303 (Ø10 mm)
- 165-83304 (Ø12 mm)

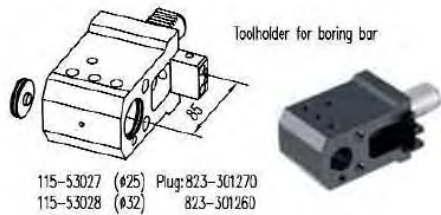

Boring bar sleeve Ø25 mm

- 165-82523 (Ø16 mm)
- 165-82524 (Ø20 mm)

Boring bar sleeve Ø32 mm

- 165-83305 (Ø16 mm)
- 165-83306 (Ø20 mm)
- 165-83307 (Ø25 mm)

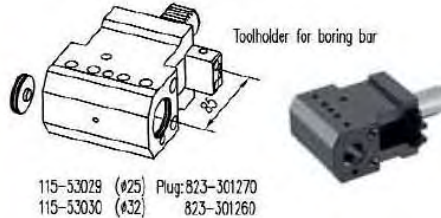

Boring bar sleeve Ø25 mm

- 165-82523 (Ø16 mm)
- 165-82524 (Ø20 mm)

Boring bar sleeve Ø32 mm

- 165-83305 (Ø16 mm)
- 165-83306 (Ø20 mm)
- 165-83307 (Ø25 mm)

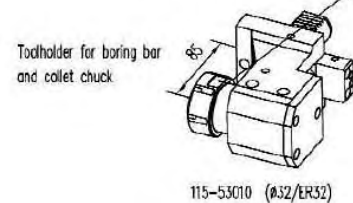
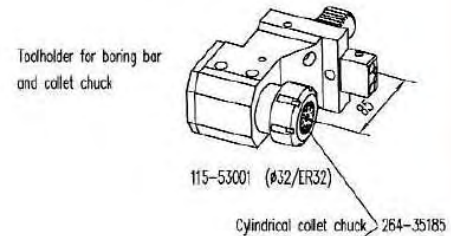
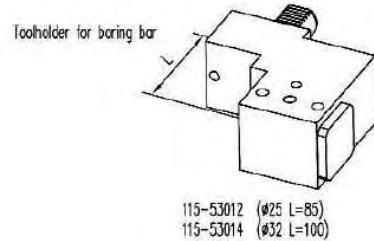
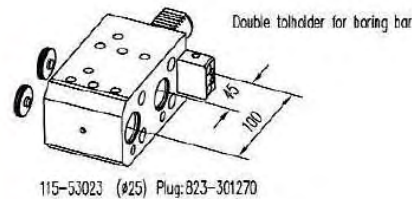

# GILDEMEISTER (VDI40)

**CTX410 V3 (option)**  
**CTX510 V3/V4**  
**CTX420 V3 (option)**  
**CTX520 V3/V4**  
**CTX Beta 500/800/1250 V3**  
**CTX Gamma 1250/2000 V3/V4 (option)**

## AXIAL TORRET

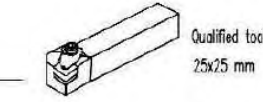
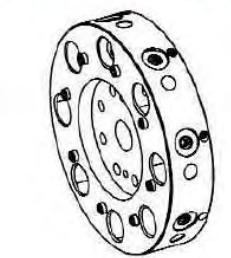

## ACCESSORIES

### Toolholder for insert drill

- E1-40x06WN (ø6 mm)
- E1-40x08WN (ø8 mm)
- E1-40x10WN (ø10 mm)
- E1-40x12WN (ø12 mm)
- E1-40x16 (ø16 mm)
- E1-40x20 (ø20 mm)
- E1-40x25 (ø25 mm)
- E1-40x32 (ø32 mm)
- E1-40x40 (ø40 mm)
- E1-40x50 (ø50 mm)

### Toolholder for boring bar

- E2-40x6 (ø6 mm)
- E2-40x8 (ø8 mm)
- E2-40x10 (ø10 mm)
- E2-40x12 (ø12 mm)
- E2-40x16 (ø16 mm)
- E2-40x20 (ø20 mm)
- E2-40x25 (ø25 mm)
- E2-40x32 (ø32 mm)
- E2-40x40 (ø40 mm)
- E2-40x50 (ø50 mm)

### Double holder for boring bar

- E7-40x32 (ø32 mm)

### Boring bar sleeve ø25 mm

- 115-62579 (ø8 mm)
- 115-62580 (ø10 mm)
- 115-62581 (ø12 mm)
- 115-62582 (ø16 mm)
- 115-62583 (ø20 mm)

### Boring bar sleeve ø32 mm

- 165-63223 (ø8 mm)
- 165-63224 (ø10 mm)
- 165-63225 (ø12 mm)
- 165-63226 (ø16 mm)
- 165-63227 (ø20 mm)
- 165-63228 (ø25 mm)

### Boring bar sleeve ø40 mm

- 165-64082 (ø8 mm)
- 165-64083 (ø10 mm)
- 165-64084 (ø12 mm)
- 165-64085 (ø16 mm)
- 165-64086 (ø20 mm)
- 165-64087 (ø25 mm)
- 165-64088 (ø32 mm)

### Toolholder for boring bar

- 118-04013 (HSK63A+C)

### Collet chuck

- E4-40x20 (ER20)
- E4-40x25 (ER25)
- E4-40x32 (ER32)
- E4-40x40 (ER40)

### Drilling chuck

- KS2-40-13 (ø1-ø13 mm)
- KS2-40-16 (ø3-ø16 mm)

# GILDEMEISTER (VDI40)

CTX410 V4/V6 (option) - CTX420 V4/V6  
 CTXBeta 500/800/1250 V4/V6  
 TWIN42/65/102 RG2 - GMX250/300/400/500  
 SPRINT65 (option)

## RADIAL TORRET

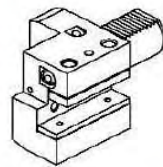

C1-40x25x85

Face and O.D. cutting holder

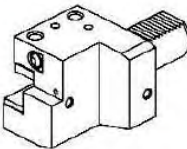

C2-40x25x85

Face and O.D. cutting holder

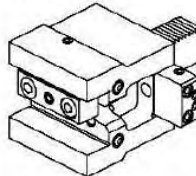

111-14035

Face and O.D. cutting holder

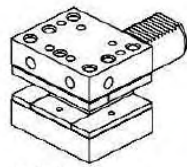

D1-40x25

Face and O.D. cutting holder

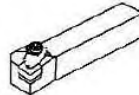
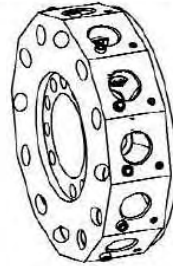

Qualified tool  
25x25 mm

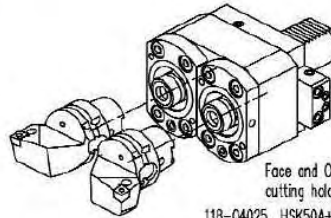

Face and O.D. cutting holder  
118-C4025 HSK50A+C



Face and O.D. cutting holder

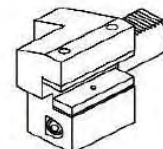

C3-40x25x85



Face and O.D. cutting holder

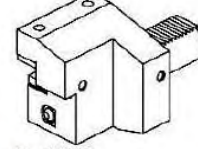

C4-40x25x85



Face and O.D. cutting holder

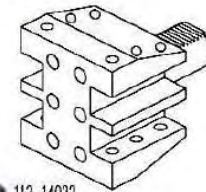

112-14022

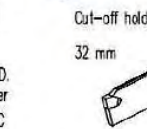

Cut-off holder  
32 mm

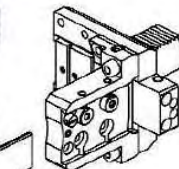

117-54006

## VDI40/VDI40 ADAPTORS

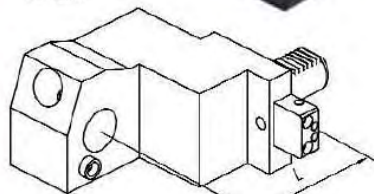

115-54139 (L=100)  
115-54141 (L=120)

Single site, right

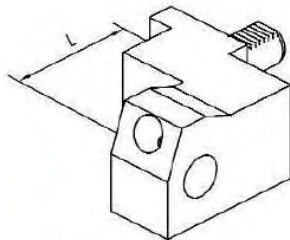

115-54140 (L=100)  
115-54142 (L=120)

Single site, left

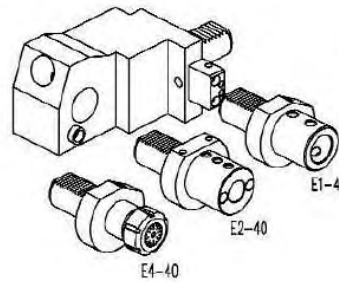

E4-40

E2-40

E1-40

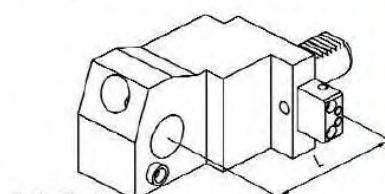

Double site, right

115-54143 (L=100)  
115-54145 (L=120)

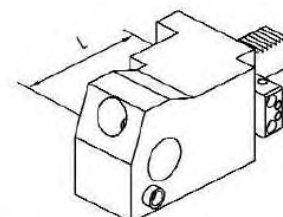

Double site, left

115-54144 (L=100)  
115-54146 (L=120)

# GILDEMEISTER (VDI40)

CTX410 V4/V6 (option) - CTX420 V4/V6  
 CTXBeta 500/800/1250 V4/V6  
 TWIN42/65/102 RG2 - GMX250/300/400/500  
 SPRINT65 (option)

## RADIAL TORRET

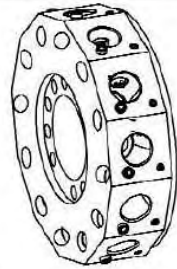

## ACCESSORIES

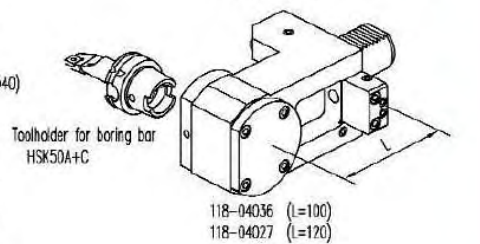
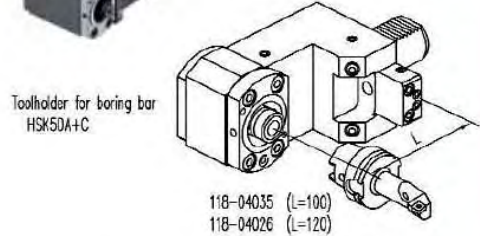
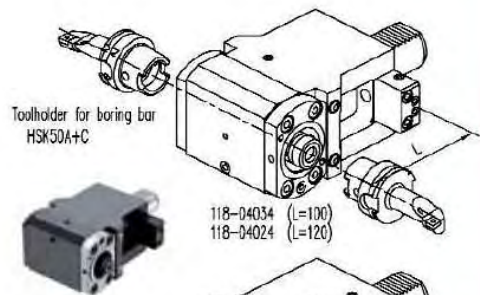
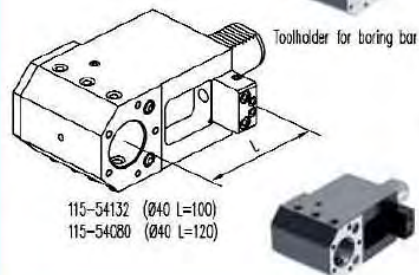
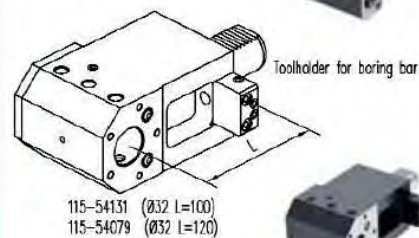
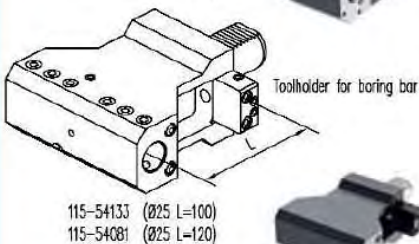
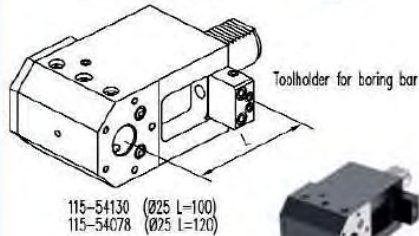
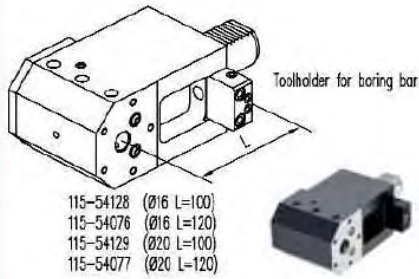

Boring bar sleeve (Ø25)

115-62579 (Ø8)  
 115-62580 (Ø10)  
 115-62581 (Ø12)  
 115-62582 (Ø16)  
 115-62583 (Ø20)

Boring bar sleeve (Ø32)

165-63223 (Ø8)  
 165-63224 (Ø10)  
 165-63225 (Ø12)  
 165-63226 (Ø16)  
 165-63227 (Ø20)  
 165-63228 (Ø25)

Boring bar sleeve (Ø40)

165-64082 (Ø8)  
 165-64083 (Ø10)  
 165-64084 (Ø12)  
 165-64085 (Ø16)  
 165-64086 (Ø20)  
 165-64087 (Ø25)  
 165-64088 (Ø32)

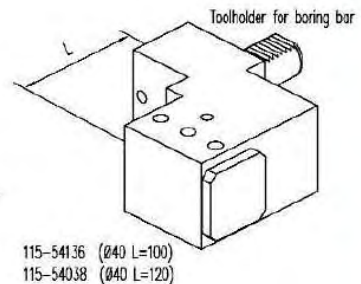
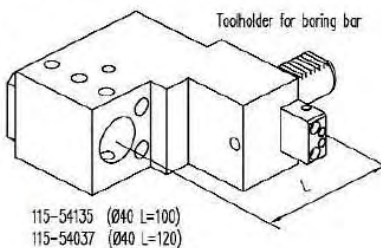
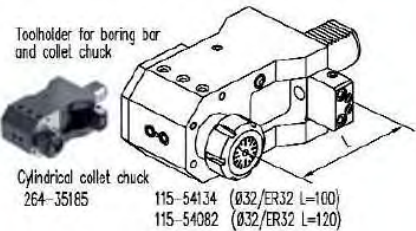
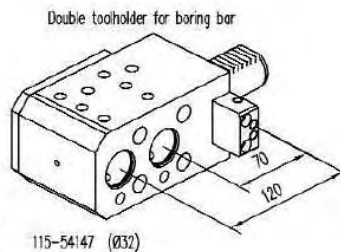

# GILDEMEISTER (VDI50)

## CTX620 V3/V4/V1 CTX Gamma 1250/2000 V3/V4 CTV400

### AXIAL TORRET

**Face and C.D. cutting holder**  
B1-50x32x55

**Face and C.D. cutting holder overhead**  
B3-50x32x55

**Face and C.D. cutting holder**  
B5-50x32x55

**Face and C.D. cutting holder overhead**  
B7-50x32x55

**Cut-off holder**  
26 mm/32 mm  
AR5026  
AR5032

**Bar puller**  
KH1-50

**VDI damped, adjustable, stop bar**  
MW-5042-AM

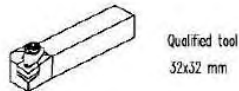
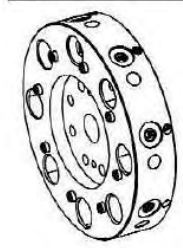

### ACCESSORIES



- Boring bar sleeve ø25 mm**
- 115-62584 (ø8 mm)
  - 115-62585 (ø10 mm)
  - 115-62586 (ø12 mm)
  - 115-62587 (ø18 mm)
  - 115-62588 (ø20 mm)

- Boring bar sleeve ø32 mm**
- 165-63229 (ø8 mm)
  - 165-63230 (ø10 mm)
  - 165-63231 (ø12 mm)
  - 165-63232 (ø16 mm)
  - 165-63233 (ø20 mm)
  - 165-63234 (ø25 mm)

- Boring bar sleeve ø40 mm**
- 165-64082 (ø8 mm)
  - 165-64083 (ø10 mm)
  - 165-64084 (ø12 mm)
  - 165-64085 (ø16 mm)
  - 165-64086 (ø20 mm)
  - 165-64087 (ø25 mm)
  - 165-64088 (ø32 mm)

- Toolholder for insert drill**
- E1-50x16 (ø16 mm)
  - E1-50x20 (ø20 mm)
  - E1-50x25 (ø25 mm)
  - E1-50x32 (ø32 mm)
  - E1-50x40 (ø40 mm)
  - E1-50x50 (ø50 mm)

- Toolholder for boring bar**
- E2-50x12 (ø12 mm)
  - E2-50x16 (ø16 mm)
  - E2-50x20 (ø20 mm)
  - E2-50x25 (ø25 mm)
  - E2-50x32 (ø32 mm)
  - E2-50x40 (ø40 mm)
  - E2-50x50 (ø50 mm)

- Double holder for boring bar**
- E7-50x32 (ø32 mm L=50 mm)
  - E7-50x50 (ø50 mm L=68 mm)

- Toolholder for boring bar**  
118-05006 (HSK63A+C)

- Collet chuck**
- E4-50x25 (ER25)
  - E4-50x32 (ER32)
  - E4-50x40 (ER40)

- Drilling chuck**
- KS2-50-13 (ø1-ø13 mm)
  - KS2-50-16 (ø3-ø16 mm)

# GILDEMEISTER (VDI50) GMX400 - GMX300 - CTX420

## ATC Turret (HSK63A)

## ICTM STANDARD

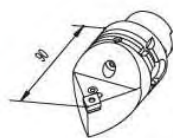

H63APCMNR12-90

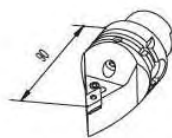

H63APDNNR15-90

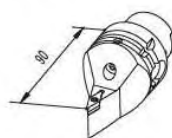

H63ASVVCN16-90

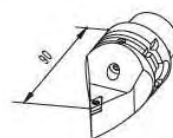

H63ASDNCN11-90



H63ADCM12DDM15-L145

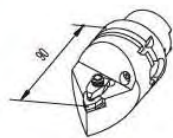

H63ADWMNR08-90

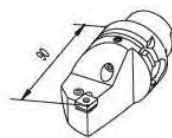

H63APCBNR12-90

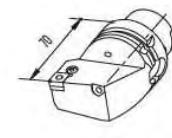

H63APCLNL/R12

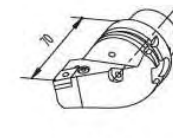

H63APDJNL/R15

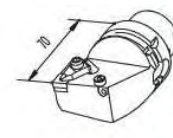

H63ADCLNL/R12

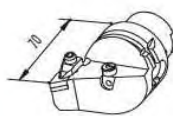

H63ADDJNL/R15

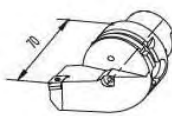

H63ASDJCL/R11



H63ASVJBL/R16

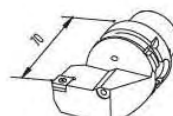

H63ASCLCL/R12

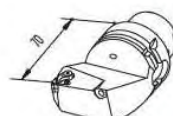

H63ATHEL/R16



141-11408 32/25

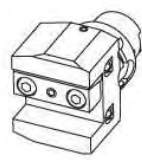

141-11406 25x25 mm

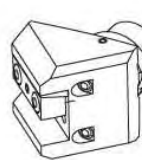

141-11405 25x25 mm

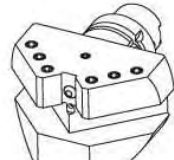

141-11409 25x25 mm

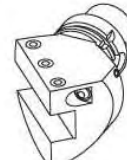

141-11407 (left) 25x25 mm  
141-21401 (right)

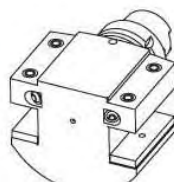

142-11405 32/25  
142-11406 32/25

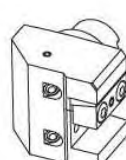

142-11402 25x25 mm

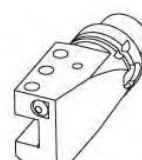

142-21401 (left) 25x25 mm  
142-21403 (right)

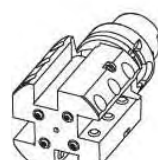

142-21404 20x20 mm (right)  
142-21403 20x20 mm (left)

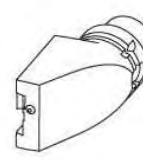

147-51405 (26mm, left)  
147-51406 (26mm, right)  
147-51407 (32mm, left)  
147-51408 (32mm, right)



145-21404 (Ø12)  
145-21406 (Ø16)  
145-21408 (Ø20)  
145-21409 (Ø25)  
145-21410 (Ø32)  
145-21411 (Ø40)



145-21412 Ø40 mm



165-64124 (Ø10 mm)  
165-64125 (Ø12 mm)  
165-64126 (Ø16 mm)  
165-64127 (Ø20 mm)



165-64128 (Ø25 mm)  
165-64129 (Ø32 mm)