

# DAEWOO PUMA

230M/MS - 240M/MS - 280LM

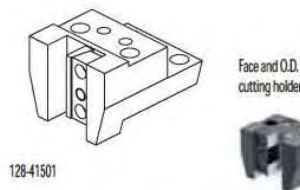

Face and O.D. cutting holder

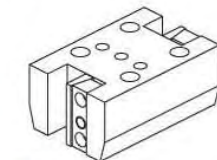

Face and O.D. cutting holder

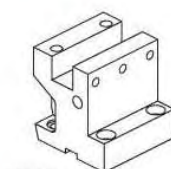

Face and I.D. cutting holder

Qualified tool  
25x25 mm

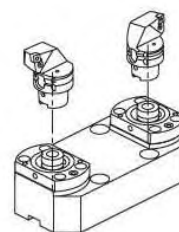

Face and O.D. cutting holder  
HSK 40 A+C

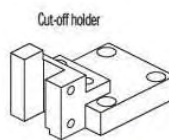

Cut-off holder

Cut-off tool  
25x25 mm



## ACCESSORIES

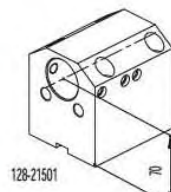

Boring bar holder  
Ø40 mm

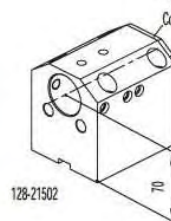

Combi toolholder for boring bar and insertdrill with internal coolant  
Ø40 mm

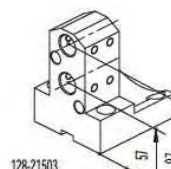

Boring bar holder  
Ø20 mm

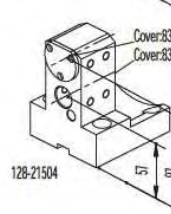

Combi toolholder for boring bar and insertdrill with internal coolant  
Ø20 mm

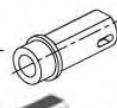

Drill socket

- 114-34012 <MT1>
- 114-34013 <MT2>
- 114-34014 <MT3>



Boring bar sleeve

- 165-64089 (Ø10 mm)
- 165-64090 (Ø12 mm)
- 165-64091 (Ø16 mm)



Boring bar sleeve

- 165-64092 (Ø20 mm)
- 165-64093 (Ø25 mm)
- 165-64094 (Ø32 mm)



Throw-away drill socket

- 165-64095 (Ø20 mm)
- 165-64096 (Ø25 mm)
- 165-64097 (Ø32 mm)



Boring bar sleeve

- 115-62027 (Ø8 mm)
- 115-62028 (Ø10 mm)
- 115-62029 (Ø12 mm)
- 115-62030 (Ø16 mm)

## CONNECTION

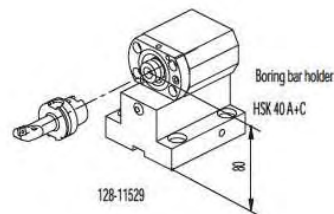
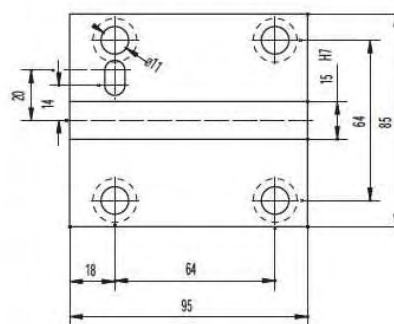

Boring bar holder  
HSK 40 A+C

# DAEWOO PUMA

230S - 240 - LYNX210

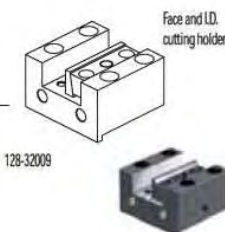
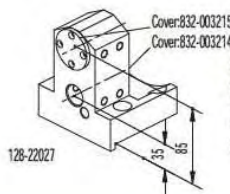
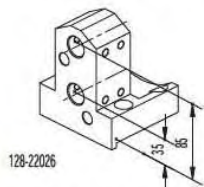
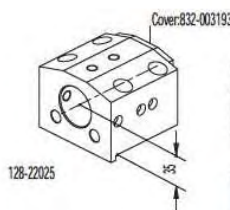
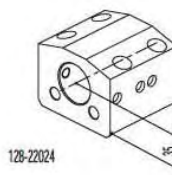
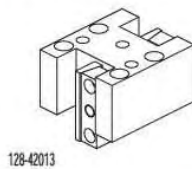
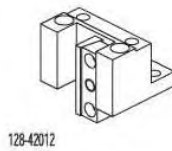
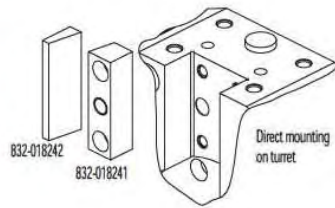

## ACCESSORIES

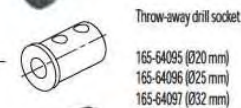
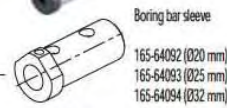
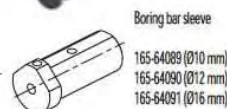
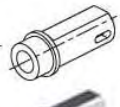

## CONNECTION

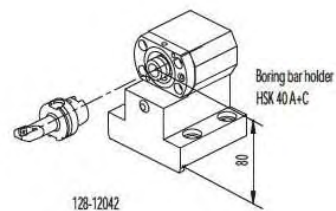
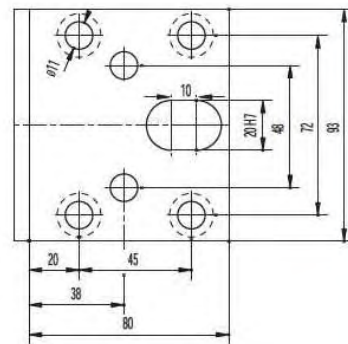

# DAEWOO PUMA

## TT1500 SY - 2000 SY - 2500 SY

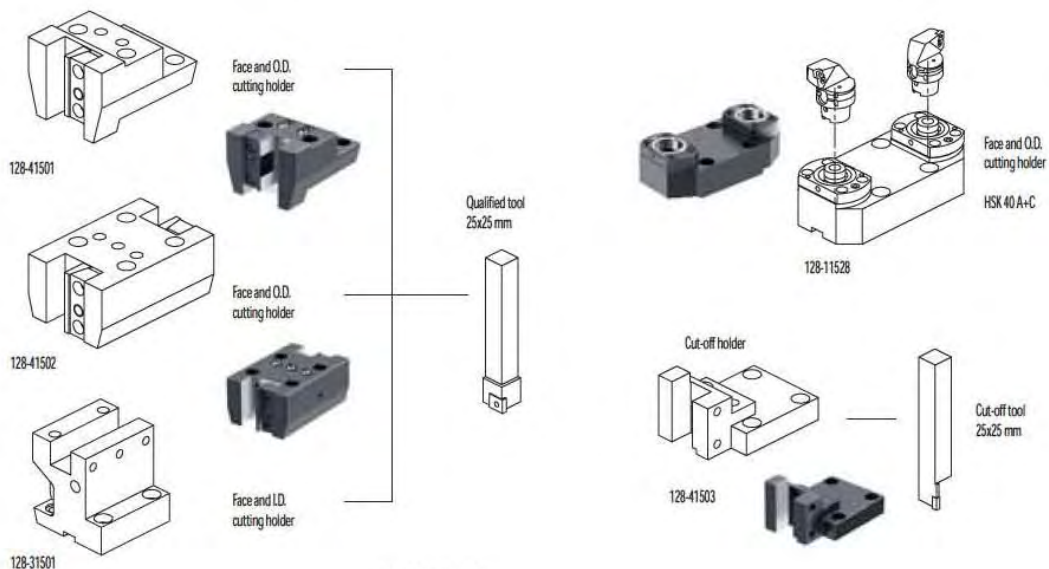

### ACCESSORIES

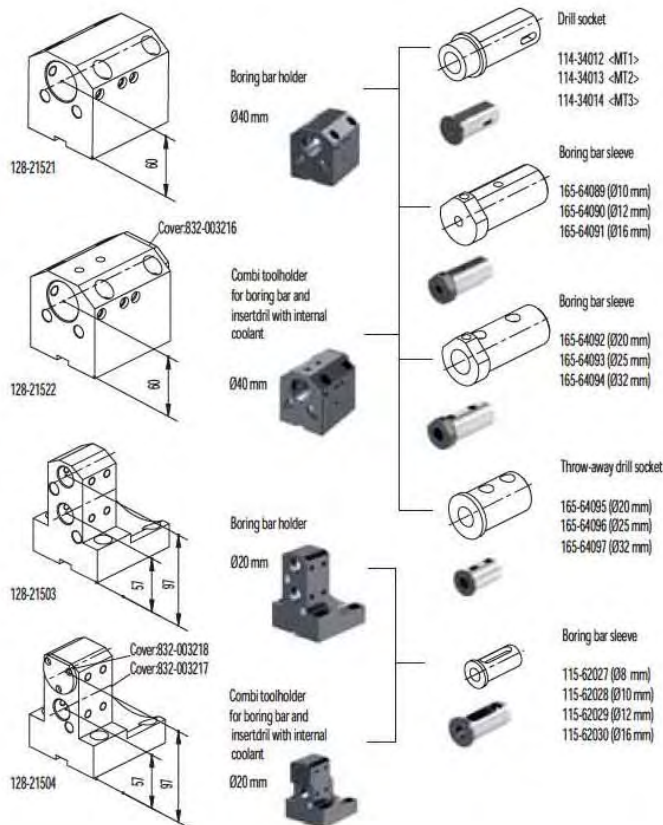

### CONNECTION

